

Fiber Cement Trim System
 by EasyTrim Reveals

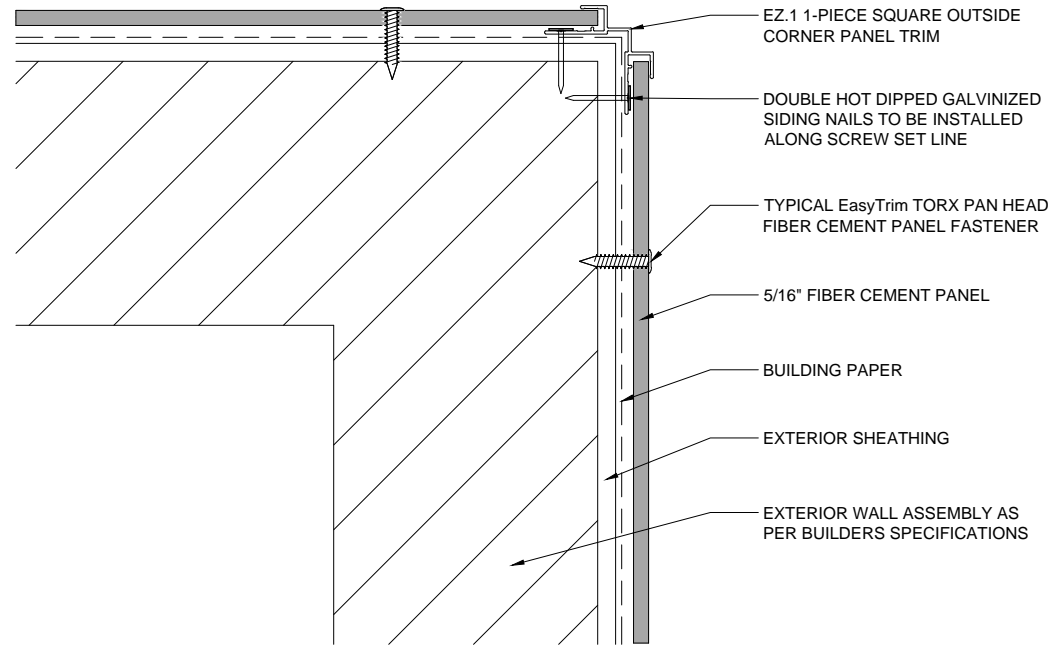

1 TYPICAL EZ.1 1-PIECE SQUARE OUTSIDE CORNER PANEL TRIM
 A1 SCALE: 3" = 1'-0"

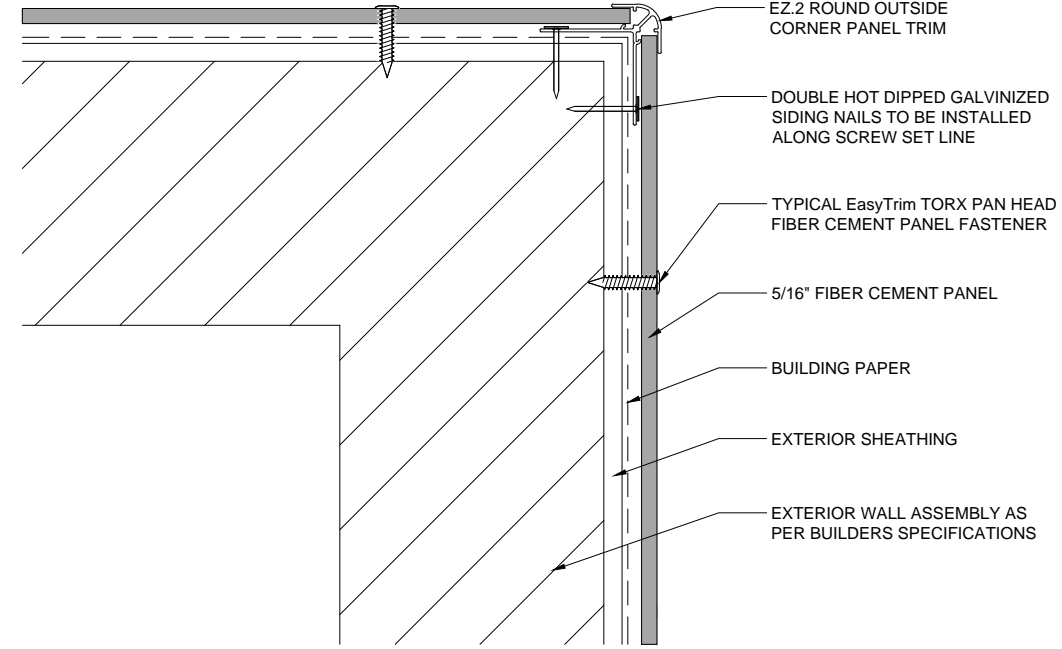

2 TYPICAL EZ.2 ROUND OUTSIDE CORNER PANEL TRIM
 A1 SCALE: 3" = 1'-0"

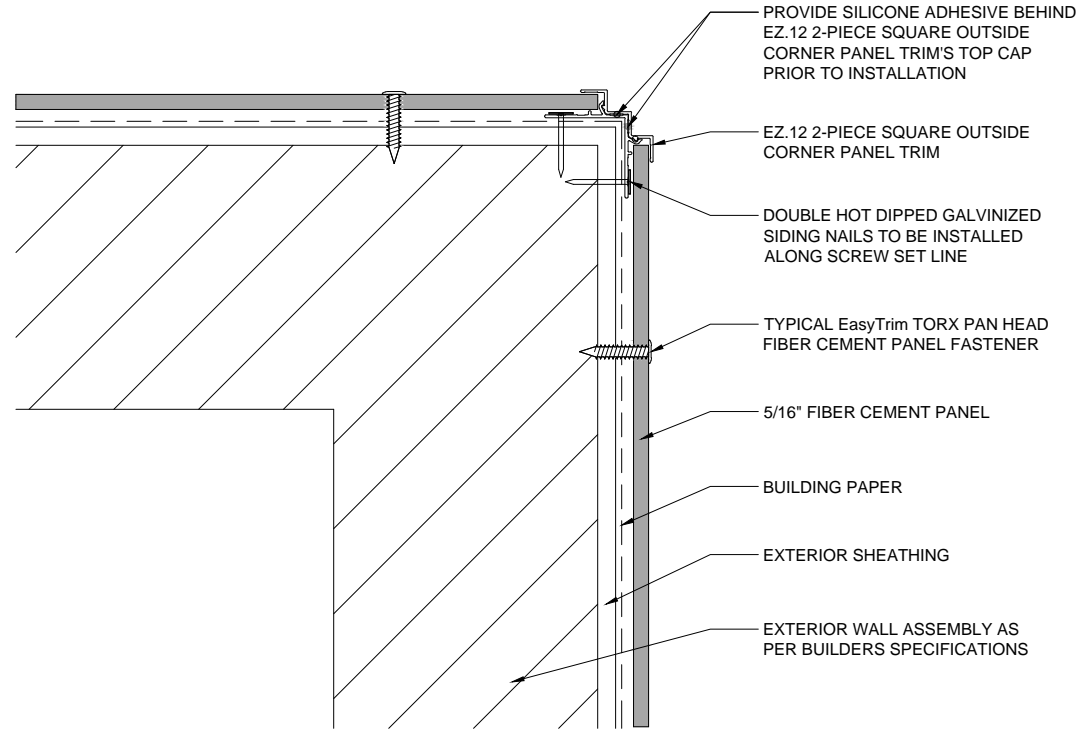

3 TYPICAL EZ.12 2-PIECE SQUARE OUTSIDE CORNER PANEL TRIM
 A1 SCALE: 3" = 1'-0"

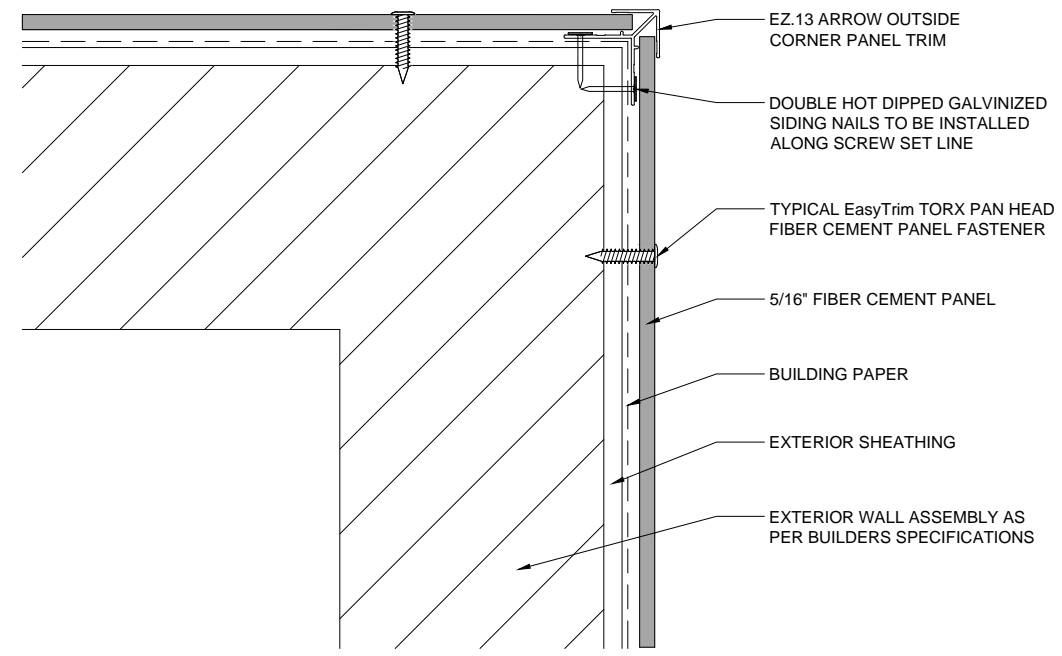

4 TYPICAL EZ.13 ARROW OUTSIDE CORNER PANEL TRIM
 A1 SCALE: 3" = 1'-0"

The contractor / builder must verify all dimensions on the job and report any discrepancy to the designer before proceeding with the work. Drawings are NOT to be scaled. All drawings and specifications are instruments of service and the copyright property of the designer and must be returned upon request.

DRAWN / REVISED BY:	REVIEWED BY:
DATE ISSUED:	DRAWING NUMBER:
PROJECT NUMBER:	A1
SCALE:	

Fiber Cement Trim System
 by EasyTrim Reveals

The contractor / builder must verify all dimensions on the job and report any discrepancy to the designer before proceeding with the work. Drawings are NOT to be scaled. All drawings and specifications are instruments of service and the copyright property of the designer and must be returned upon request.

DRAWN / REVISED BY:	REVIEWED BY:
DATE ISSUED:	DRAWING NUMBER:
PROJECT NUMBER:	A2
SCALE:	

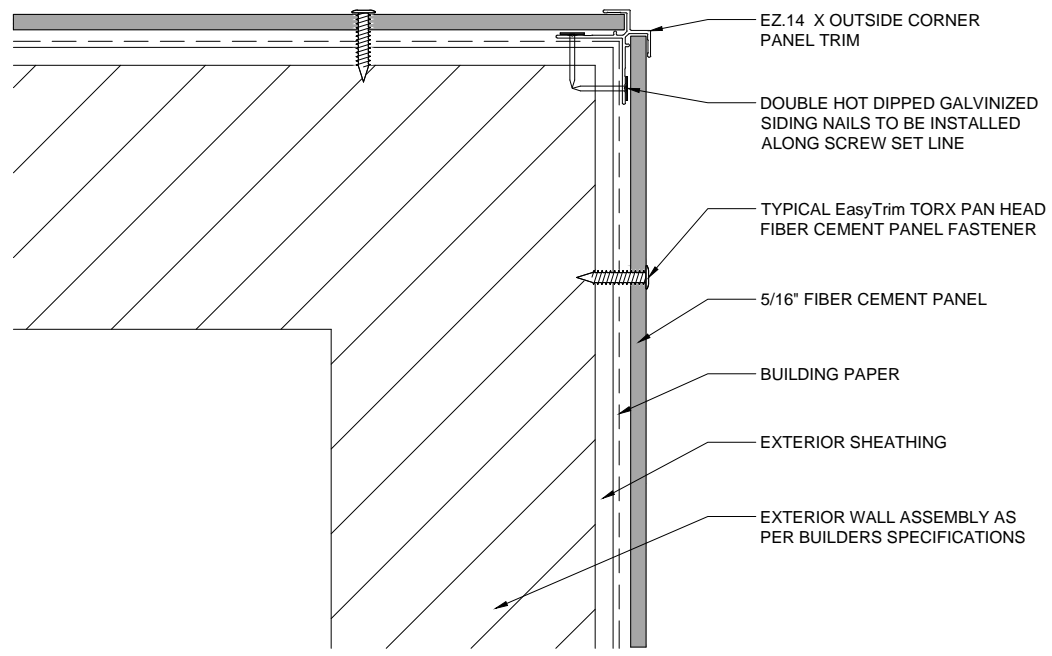

5 TYPICAL EZ.14 X OUTSIDE CORNER PANEL TRIM
 A2 SCALE: 3" = 1'-0"

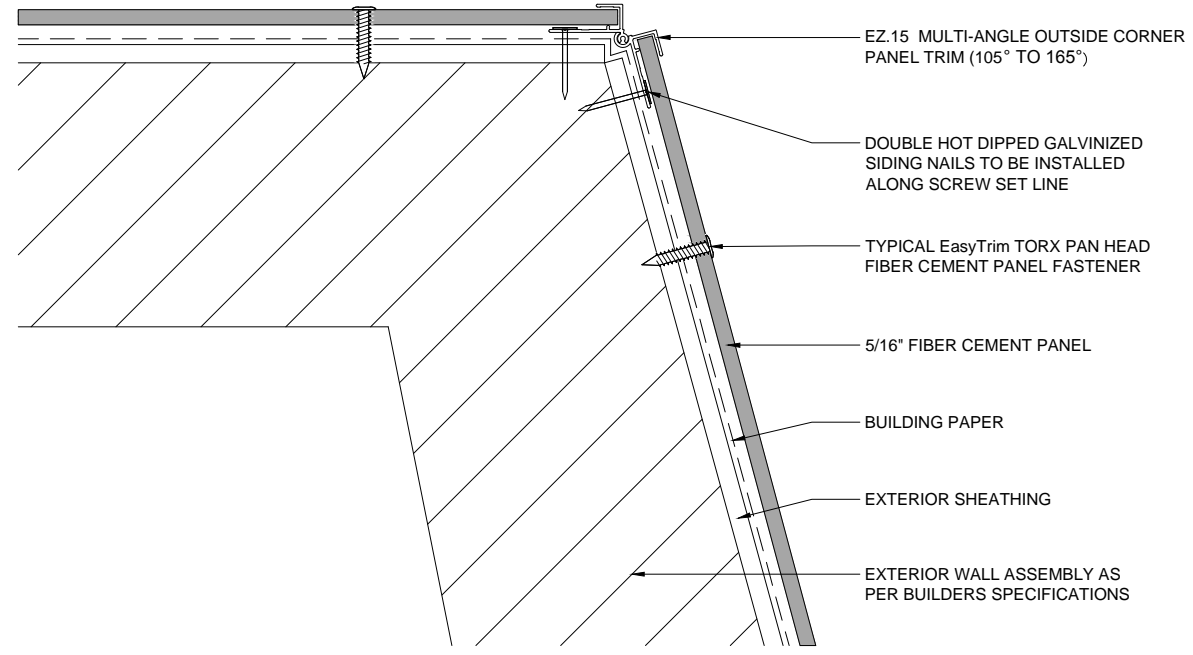

6 TYPICAL EZ.15 MULTI-ANGLE OUTSIDE CORNER PANEL TRIM (105° TO 165°)
 A2 SCALE: 3" = 1'-0"

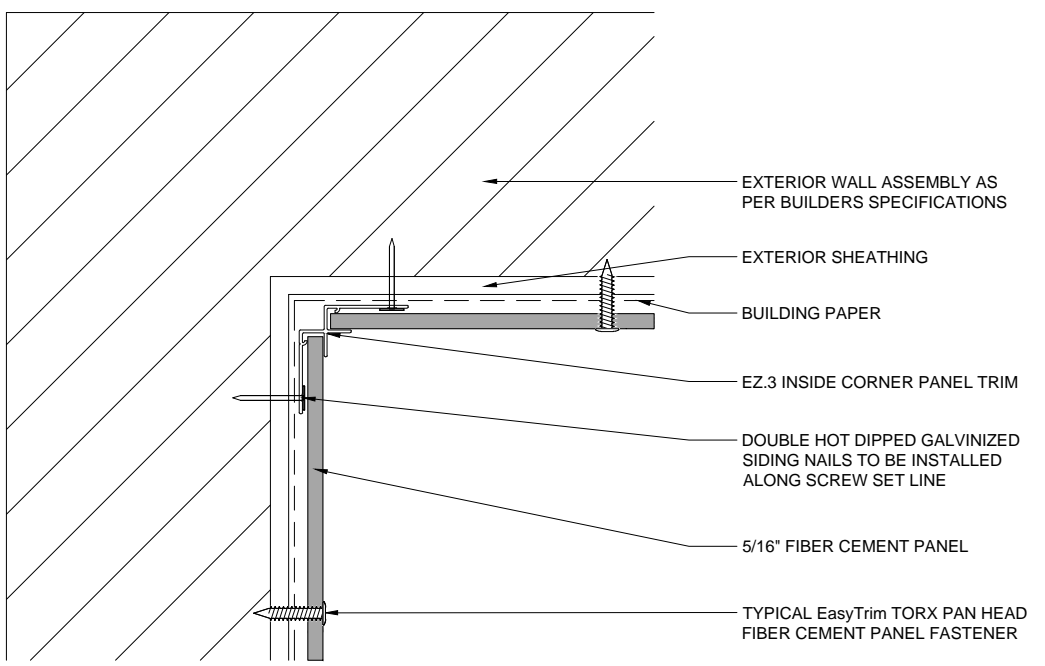

7 TYPICAL EZ.3 INSIDE CORNER PANEL TRIM
 A2 SCALE: 3" = 1'-0"

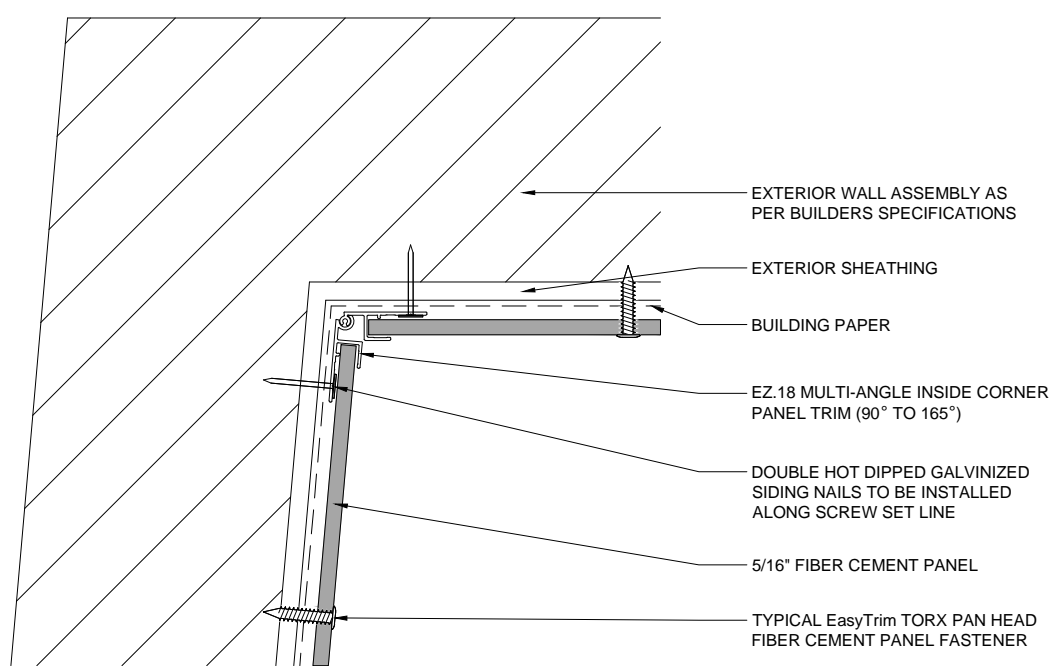

8 TYPICAL EZ.18 MULTI-ANGLE INSIDE CORNER PANEL TRIM (90° TO 165°)
 A2 SCALE: 3" = 1'-0"

Fiber Cement Trim System
 by EasyTrim Reveals

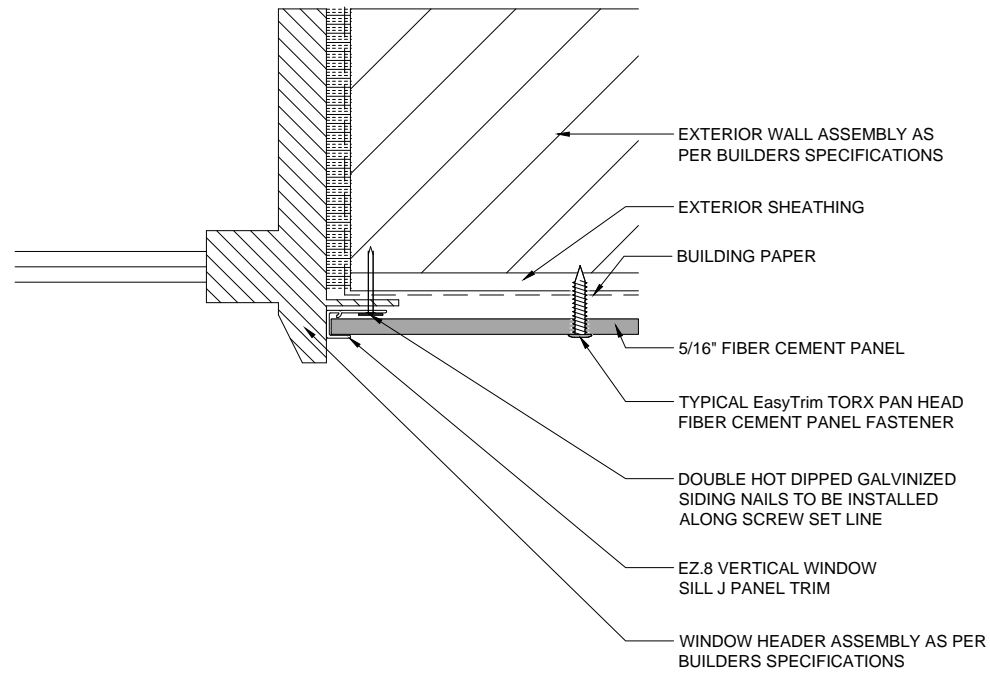

9 TYPICAL EZ.8 VERTICAL WINDOW SILL J PANEL TRIM
 A3 SCALE: 3" = 1'-0"

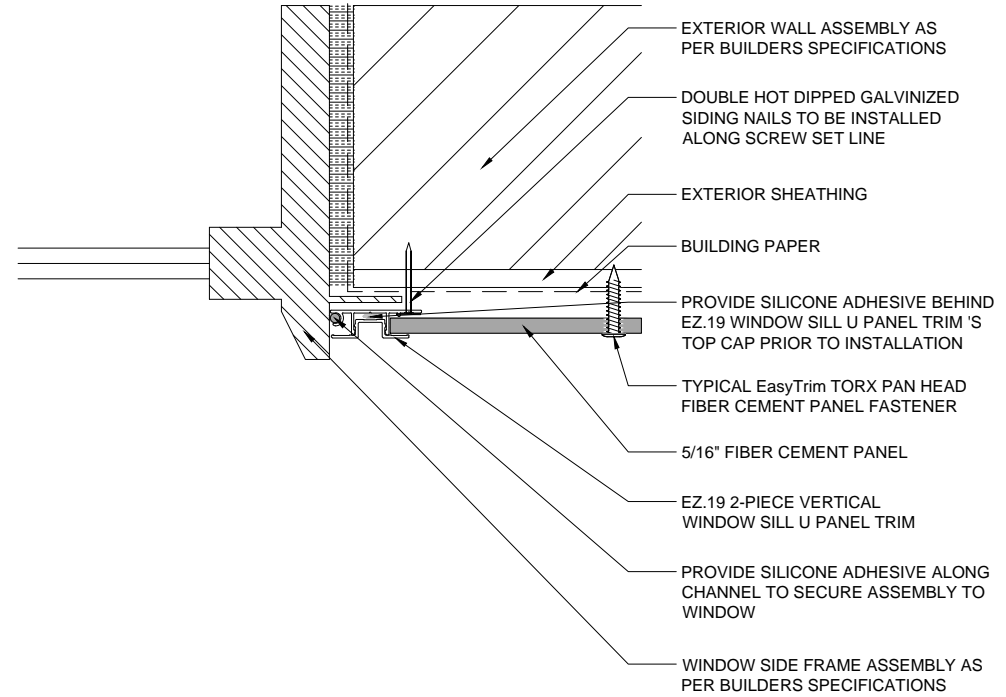

10 TYPICAL EZ.19 2-PIECE VERTICAL WINDOW SILL U PANEL TRIM
 A3 SCALE: 3" = 1'-0"

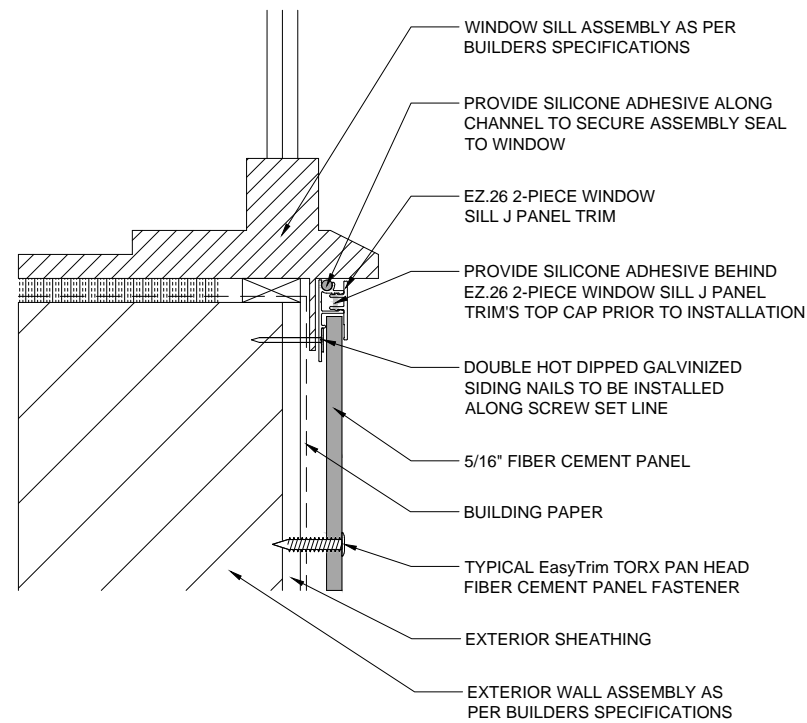

11 TYPICAL EZ.26 2-PIECE WINDOW SILL J PANEL TRIM
 A3 SCALE: 3" = 1'-0"

The contractor / builder must verify all dimensions on the job and report any discrepancy to the designer before proceeding with the work. Drawings are NOT to be scaled. All drawings and specifications are instruments of service and the copyright property of the designer and must be returned upon request.

DRAWN / REVISED BY:	REVIEWED BY:
DATE ISSUED:	DRAWING NUMBER:
PROJECT NUMBER:	A3
SCALE:	

Fiber Cement Trim System
 by EasyTrim Reveals

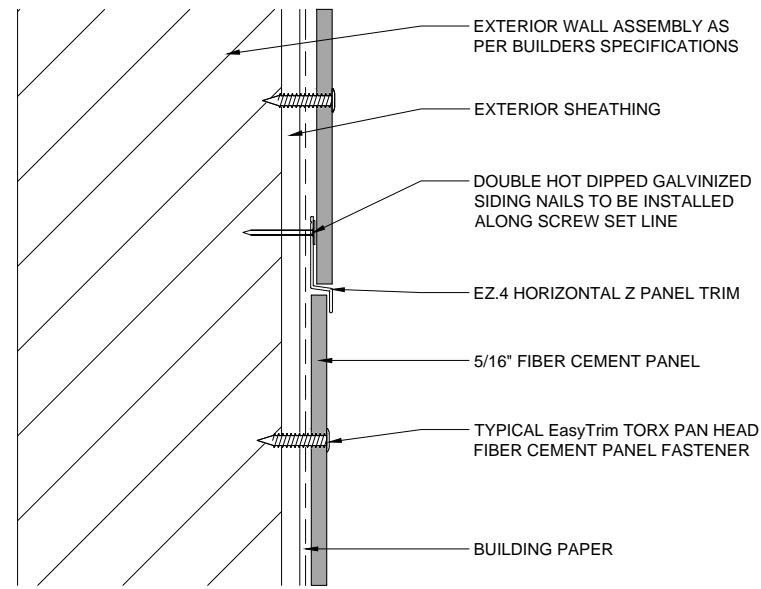

12 TYPICAL EZ.4 HORIZONTAL Z PANEL TRIM
 A4 SCALE: 3" = 1'-0"

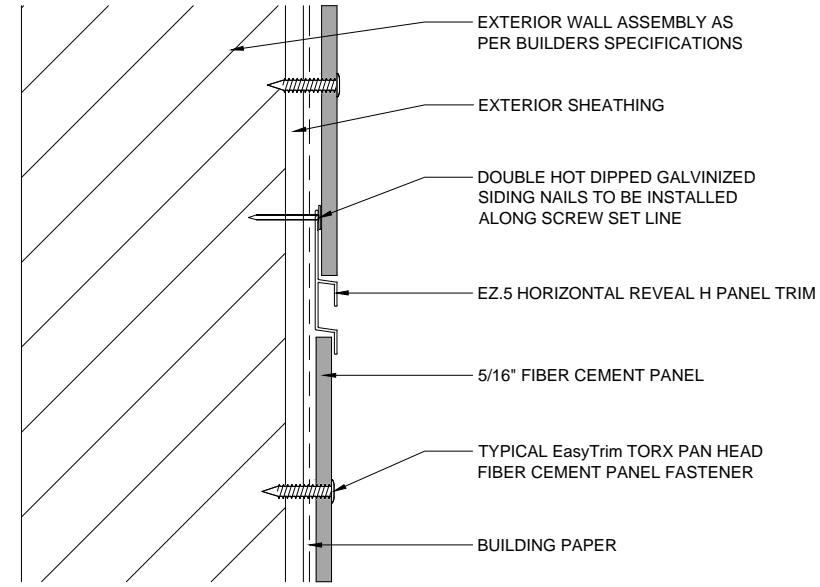

13 TYPICAL EZ.5 HORIZONTAL REVEAL H PANEL TRIM
 A4 SCALE: 3" = 1'-0"

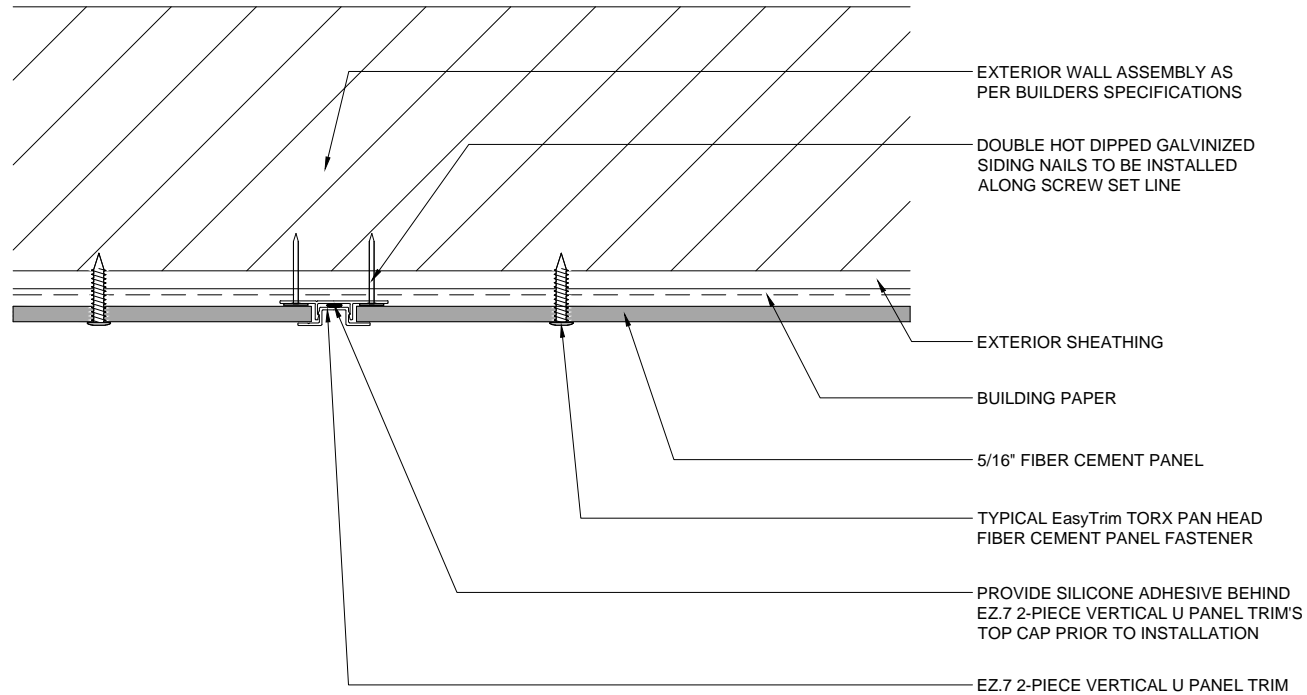

14 TYPICAL EZ.7 2-PIECE VERTICAL U PANEL TRIM
 A4 SCALE: 3" = 1'-0"

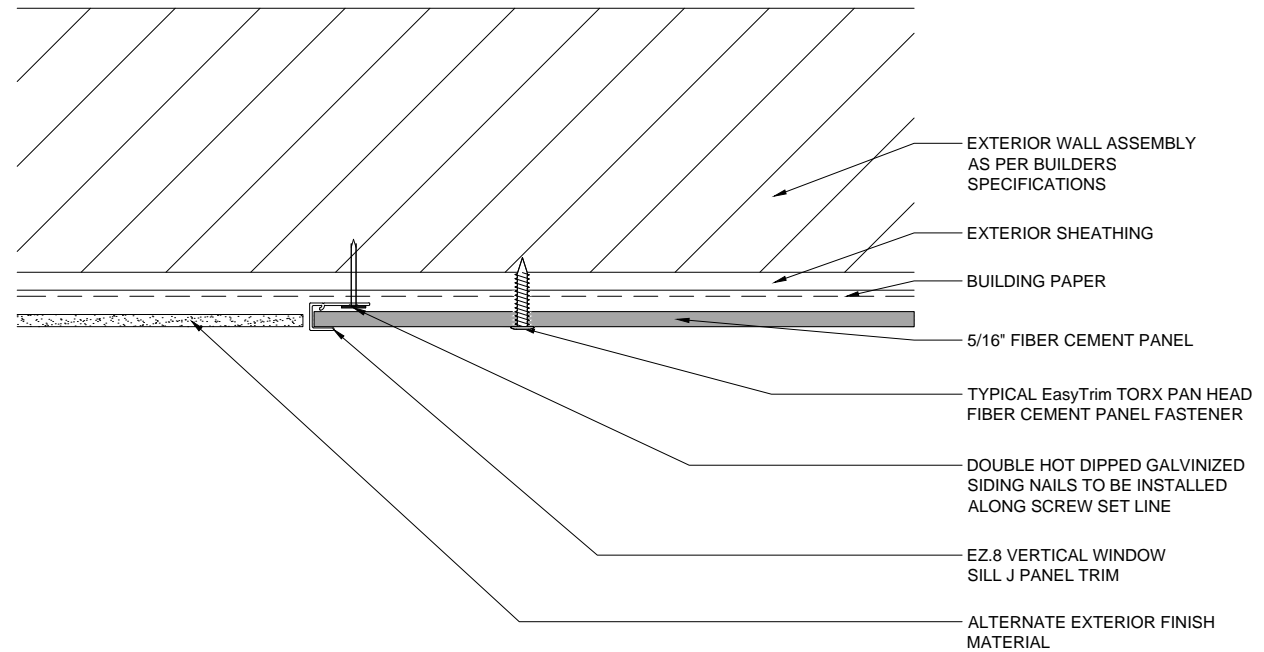

15 ALTERNATE EZ.8 VERTICAL WINDOW SILL J PANEL TRIM
 A4 SCALE: 3" = 1'-0"

The contractor / builder must verify all dimensions on the job and report any discrepancy to the designer before proceeding with the work. Drawings are NOT to be scaled. All drawings and specifications are instruments of service and the copyright property of the designer and must be returned upon request.

DRAWN / REVISED BY:	REVIEWED BY:
DATE ISSUED:	DRAWING NUMBER:
PROJECT NUMBER:	A4
SCALE:	

Fiber Cement Trim System
 by EasyTrim Reveals

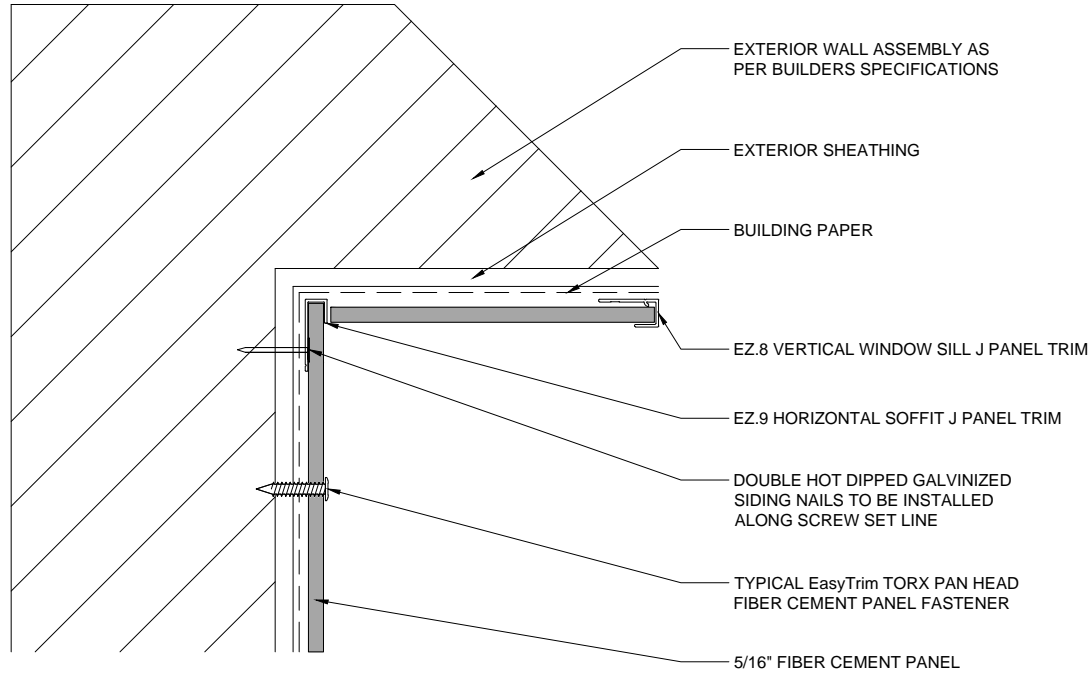

16 TYPICAL EZ.9 HORIZONTAL SOFFIT J PANEL TRIM
 A5 SCALE: 3" = 1'-0"

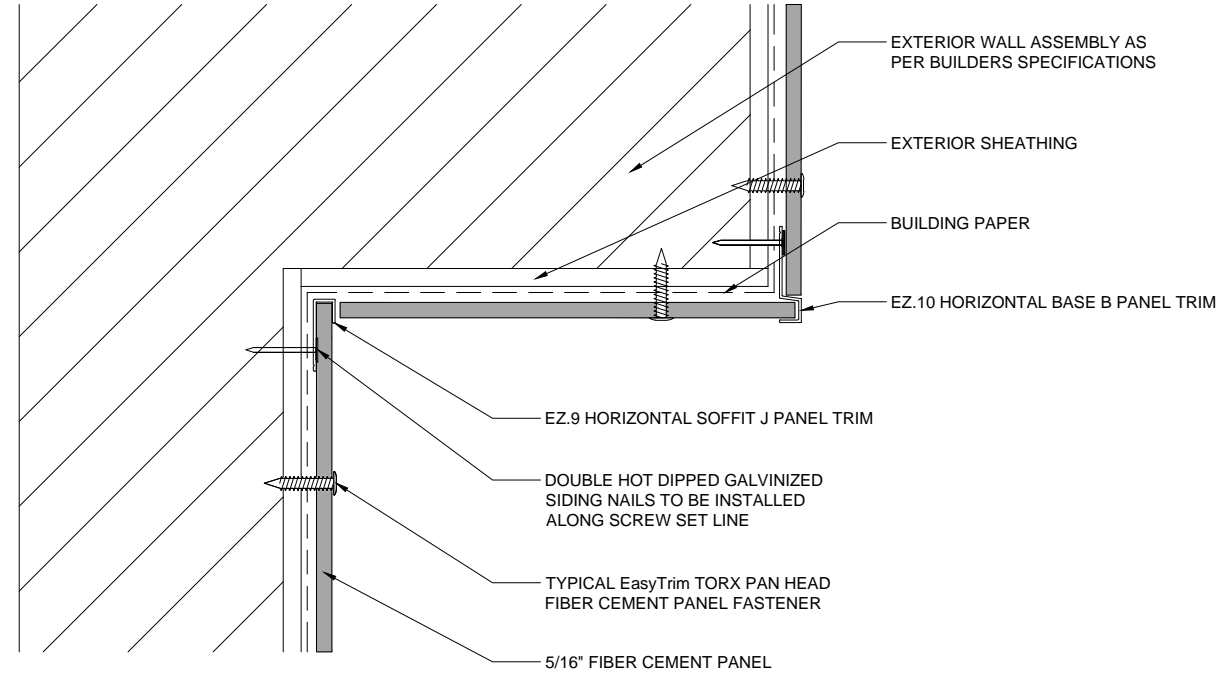

17 ALTERNATE EZ.9 HORIZONTAL SOFFIT J PANEL TRIM
 A5 SCALE: 3" = 1'-0"

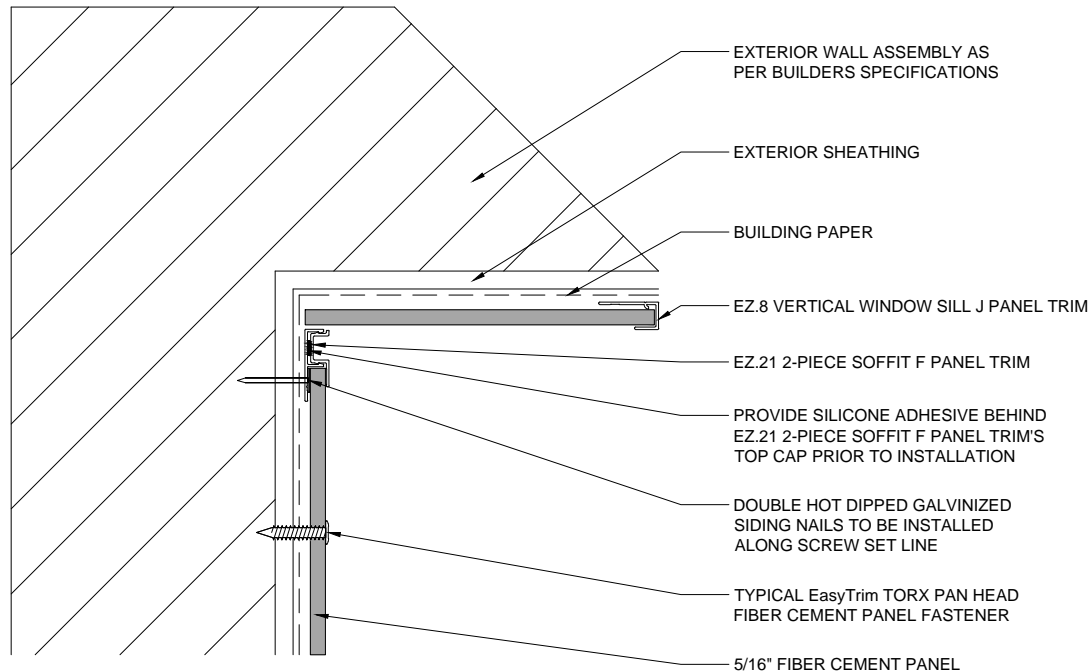

18 TYPICAL EZ.21 2-PIECE SOFFIT F PANEL TRIM
 A5 SCALE: 3" = 1'-0"

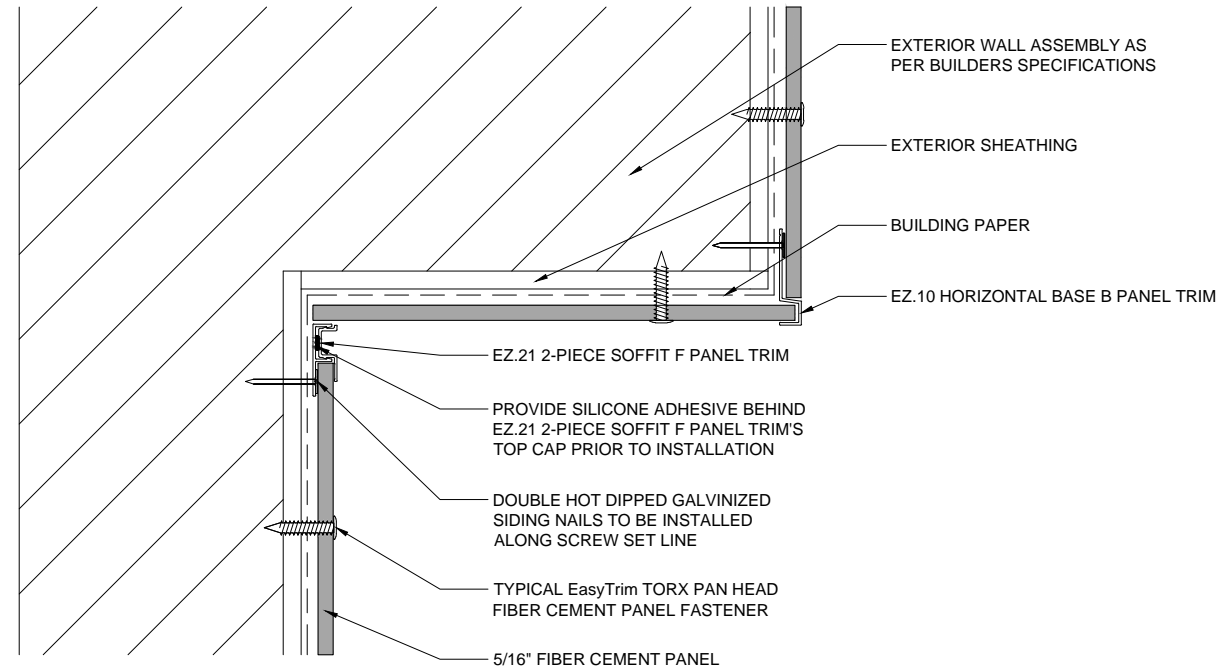

19 ALTERNATE EZ.21 2-PIECE SOFFIT F PANEL TRIM
 A5 SCALE: 3" = 1'-0"

The contractor / builder must verify all dimensions on the job and report any discrepancy to the designer before proceeding with the work. Drawings are NOT to be scaled. All drawings and specifications are instruments of service and the copyright property of the designer and must be returned upon request.

DRAWN / REVISED BY:	REVIEWED BY:
DATE ISSUED:	DRAWING NUMBER:
PROJECT NUMBER:	A5
SCALE:	

Fiber Cement Trim System

by EasyTrim Reveals

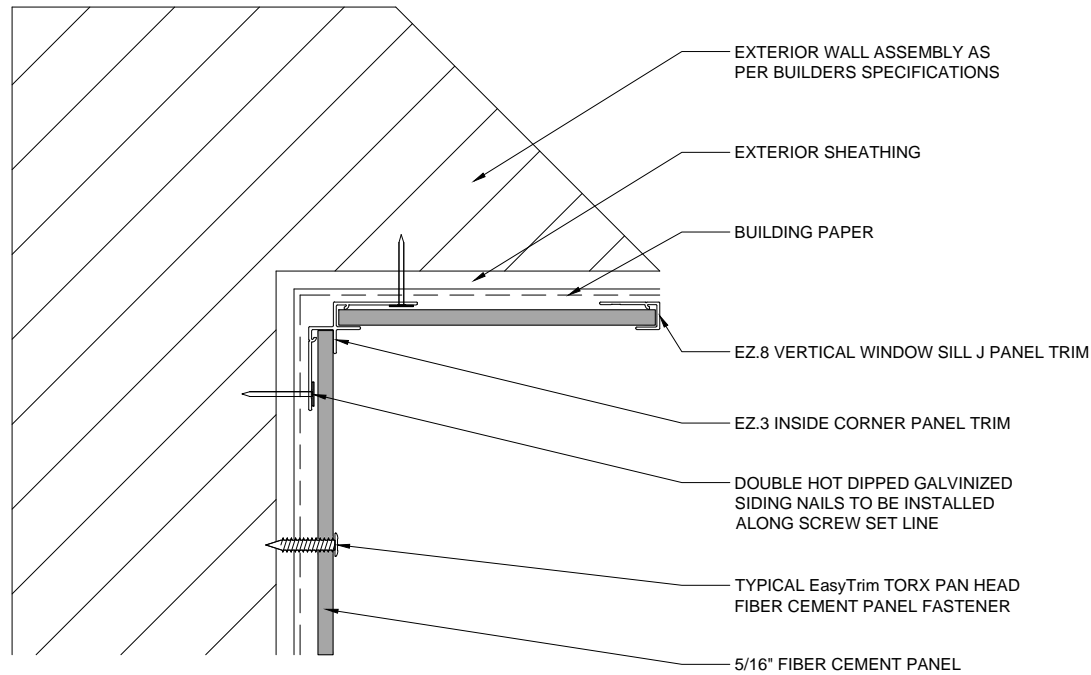

20 ALTERNATE EZ.3 INSIDE CORNER PANEL
 A6 SCALE: 3" = 1'-0"

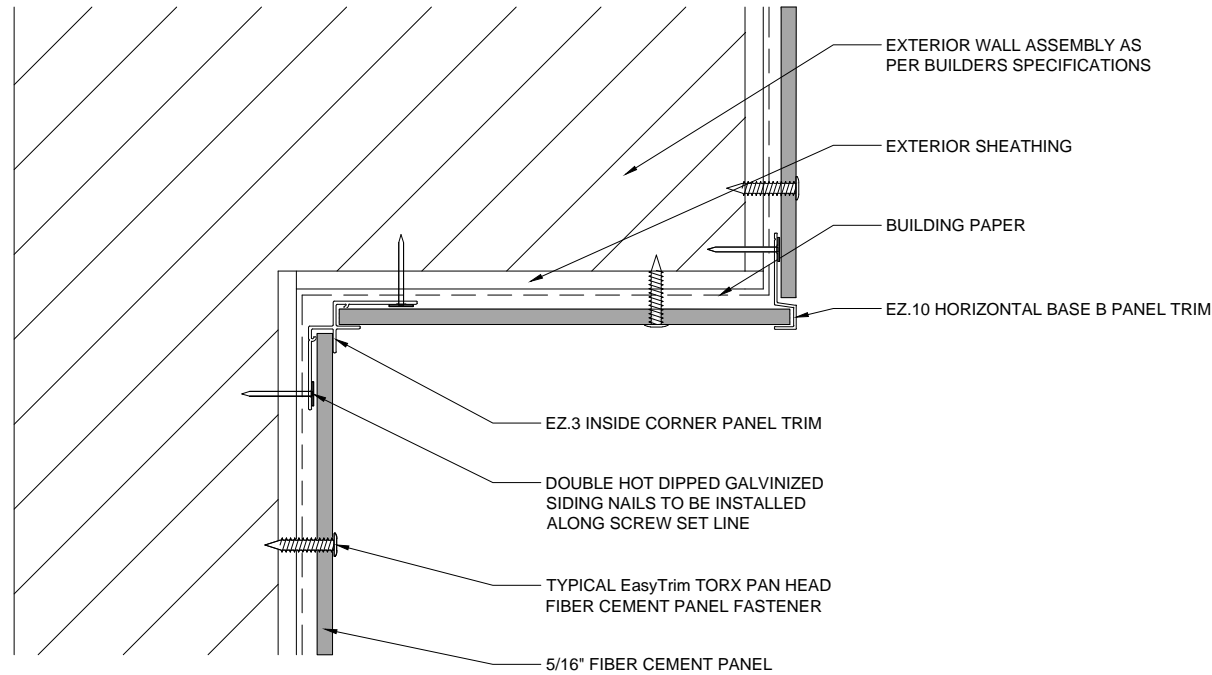

21 ALTERNATE EZ.3 INSIDE CORNER PANEL
 A6 SCALE: 3" = 1'-0"

The contractor / builder must verify all dimensions on the job and report any discrepancy to the designer before proceeding with the work. Drawings are NOT to be scaled. All drawings and specifications are instruments of service and the copyright property of the designer and must be returned upon request.

DRAWN / REVISED BY:	REVIEWED BY:
DATE ISSUED:	DRAWING NUMBER:
PROJECT NUMBER:	A6
SCALE:	

Fiber Cement Trim System
 by EasyTrim Reveals

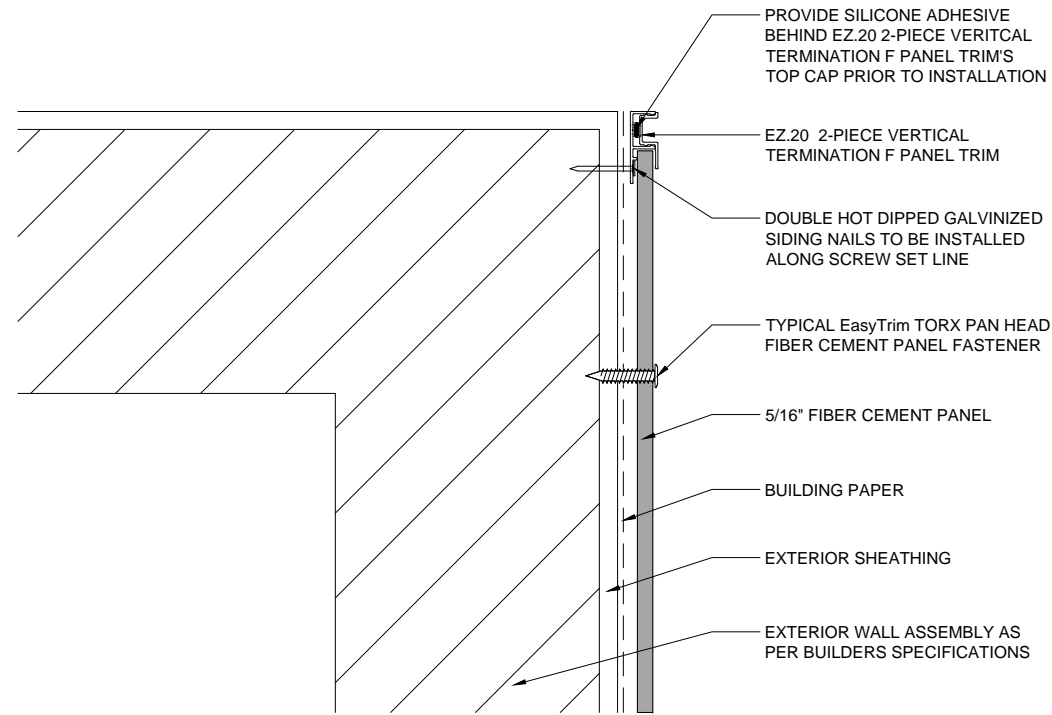

22 TYPICAL EZ.20 2-PIECE VERTICAL TERMINATION F PANEL TRIM
 A7 SCALE: 3" = 1'-0"

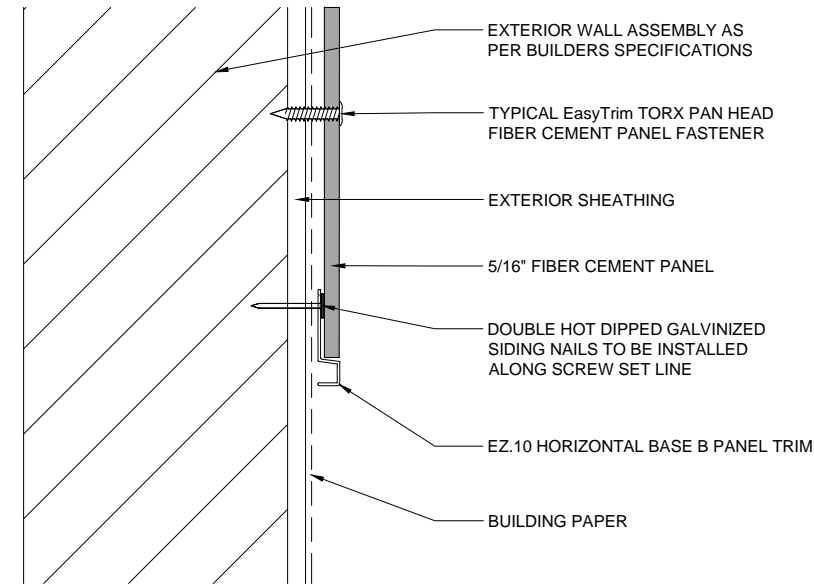

23 TYPICAL EZ.10 HORIZONTAL BASE B PANEL TRIM
 A7 SCALE: 3" = 1'-0"

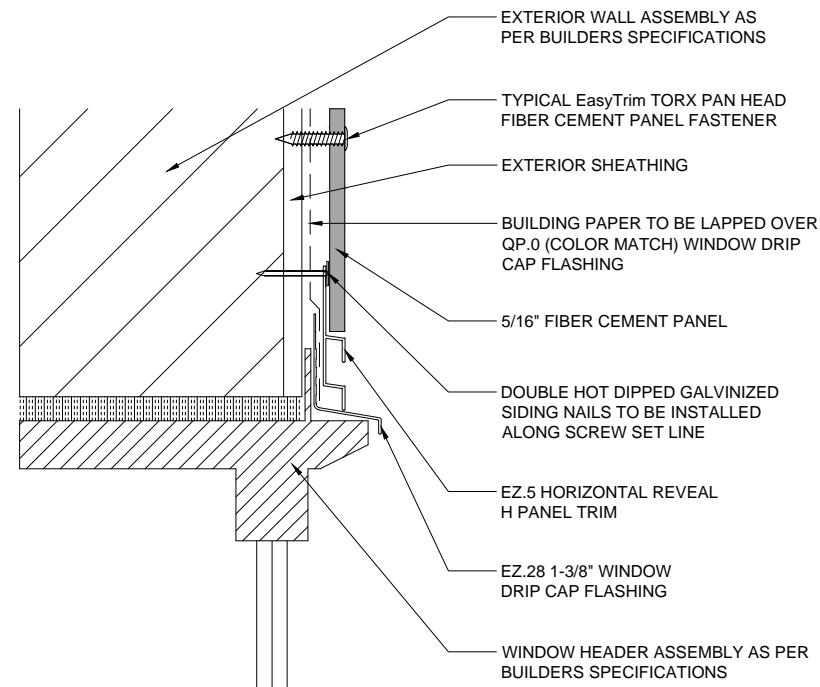

24 TYPICAL EZ.28 1-3/8" WINDOW DRIP CAP FLASHING
 A7 SCALE: 3" = 1'-0"

The contractor / builder must verify all dimensions on the job and report any discrepancy to the designer before proceeding with the work. Drawings are NOT to be scaled. All drawings and specifications are instruments of service and the copyright property of the designer and must be returned upon request.

DRAWN / REVISED BY:	REVIEWED BY:
DATE ISSUED:	DRAWING NUMBER:
PROJECT NUMBER:	A7
SCALE:	

Fiber Cement Trim System
 by EasyTrim Reveals

The contractor / builder must verify all dimensions on the job and report any discrepancy to the designer before proceeding with the work. Drawings are NOT to be scaled. All drawings and specifications are instruments of service and the copyright property of the designer and must be returned upon request.

DRAWN / REVISED BY:	REVIEWED BY:
DATE ISSUED:	DRAWING NUMBER:
PROJECT NUMBER:	A8
SCALE:	

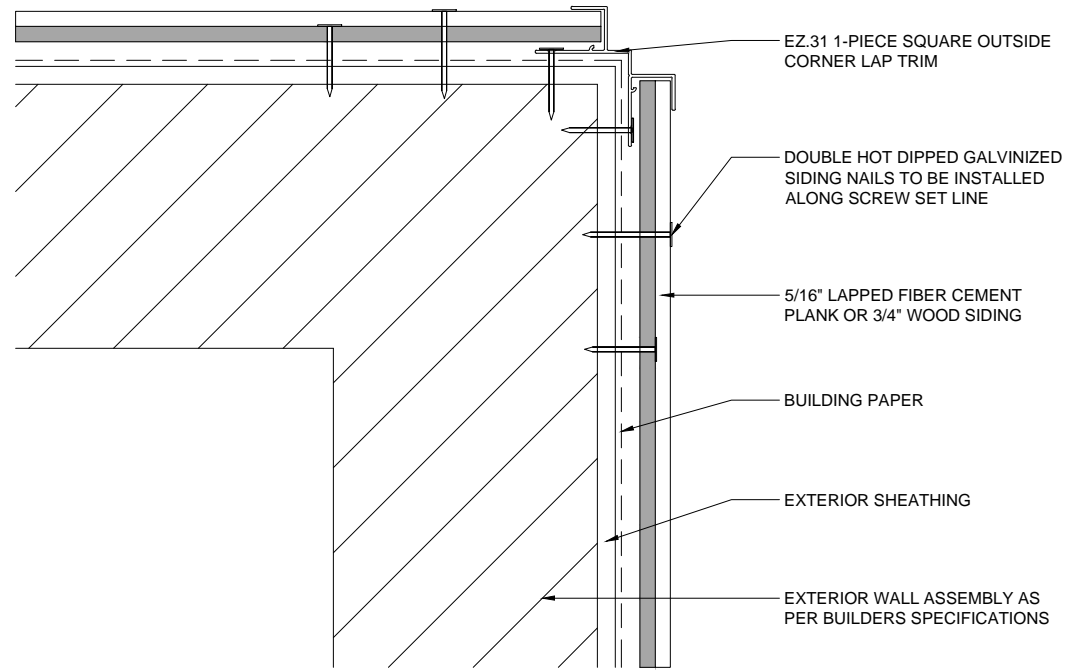

25 TYPICAL EZ.31 1-PIECE SQUARE OUTSIDE CORNER LAP TRIM
A8 SCALE: 3" = 1'-0"

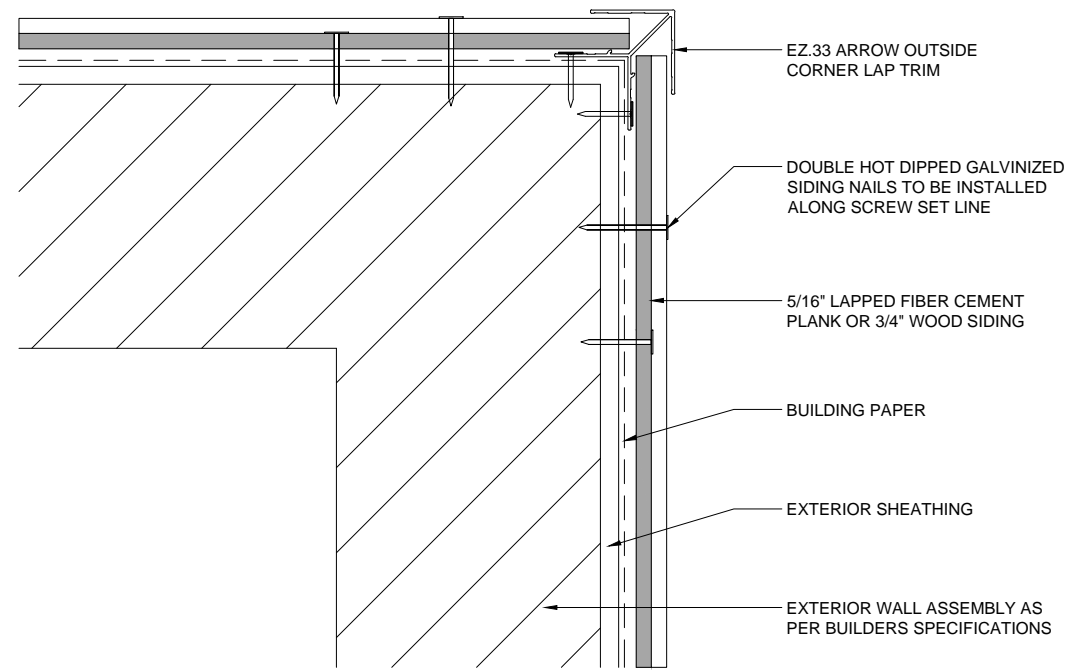

26 TYPICAL EZ.33 ARROW OUTSIDE CORNER LAP TRIM
A8 SCALE: 3" = 1'-0"

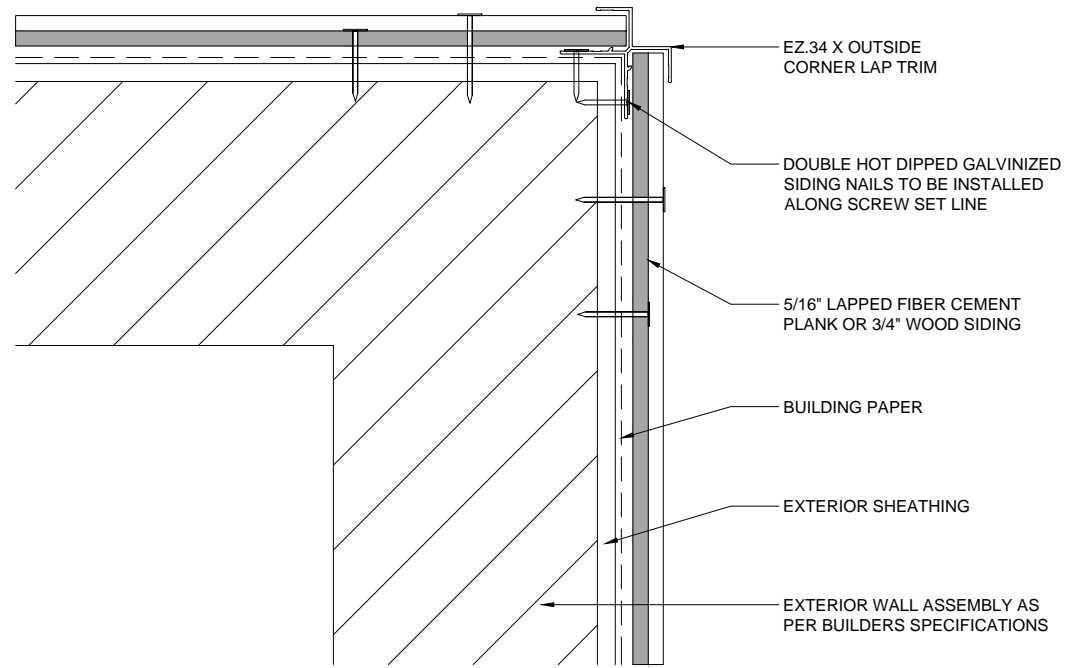

27 TYPICAL EZ.34 X OUTSIDE CORNER LAP TRIM
A8 SCALE: 3" = 1'-0"

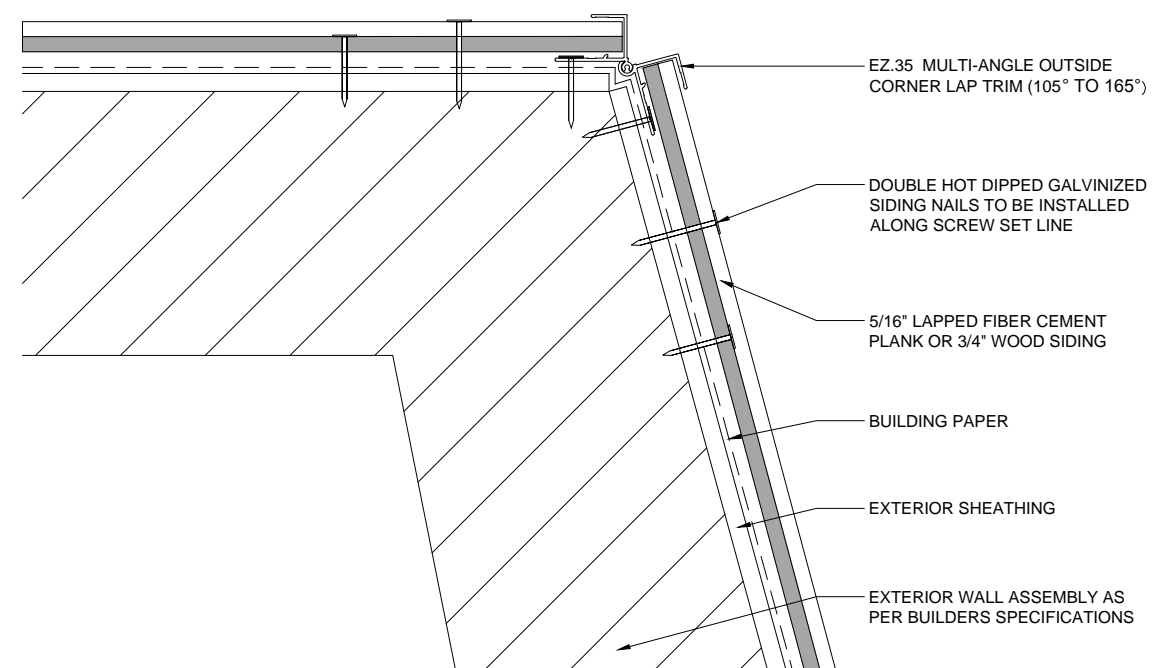

28 TYPICAL EZ.35 MULTI-ANGLE OUTSIDE CORNER LAP TRIM (105° TO 165°)
A8 SCALE: 3" = 1'-0"

Fiber Cement Trim System

by EasyTrim Reveals

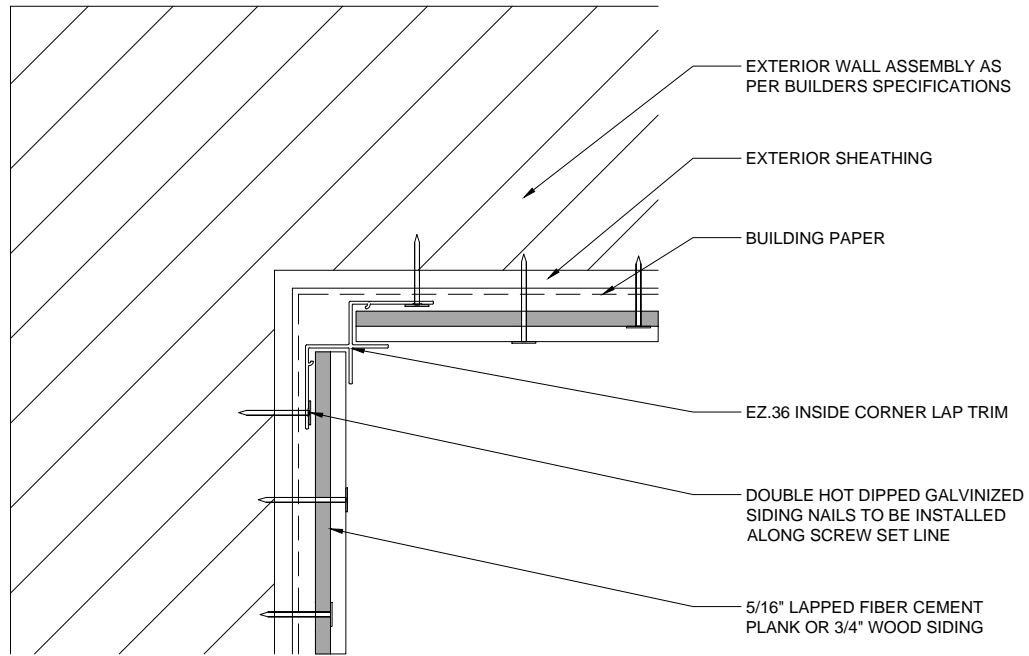

29 TYPICAL EZ.36 INSIDE CORNER LAP TRIM
 A9 SCALE: 3" = 1'-0"

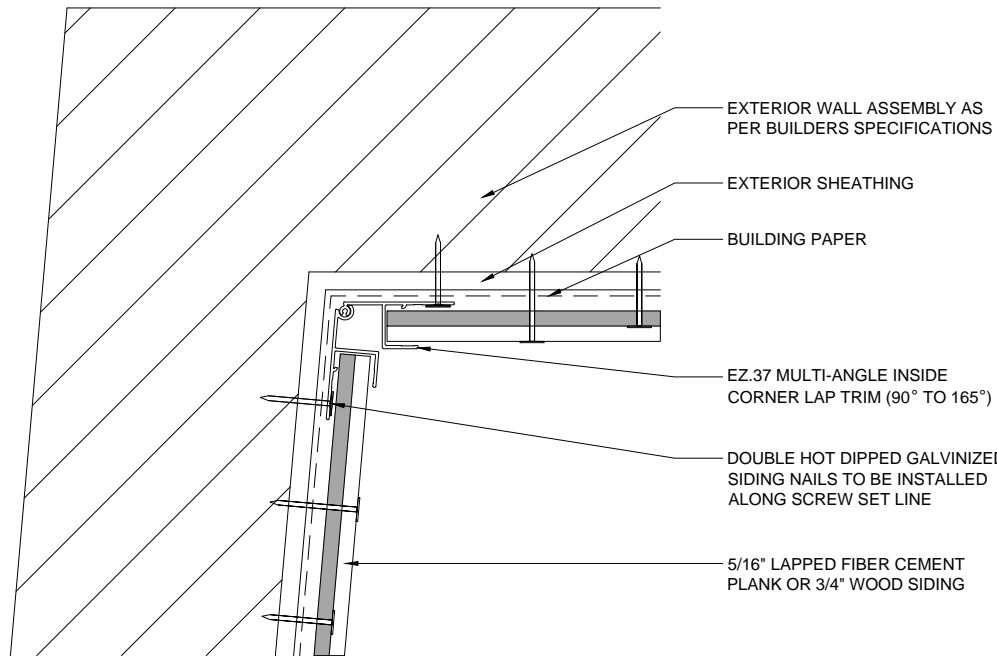

30 TYPICAL EZ.37 MULTI-ANGLE INSIDE CORNER LAP TRIM (90° TO 165°)
 A9 SCALE: 3" = 1'-0"

The contractor / builder must verify all dimensions on the job and report any discrepancy to the designer before proceeding with the work. Drawings are NOT to be scaled. All drawings and specifications are instruments of service and the copyright property of the designer and must be returned upon request.

DRAWN / REVISED BY:	REVIEWED BY:
DATE ISSUED:	DRAWING NUMBER:
PROJECT NUMBER:	A9
SCALE:	

Fiber Cement Trim System
 by EasyTrim Reveals

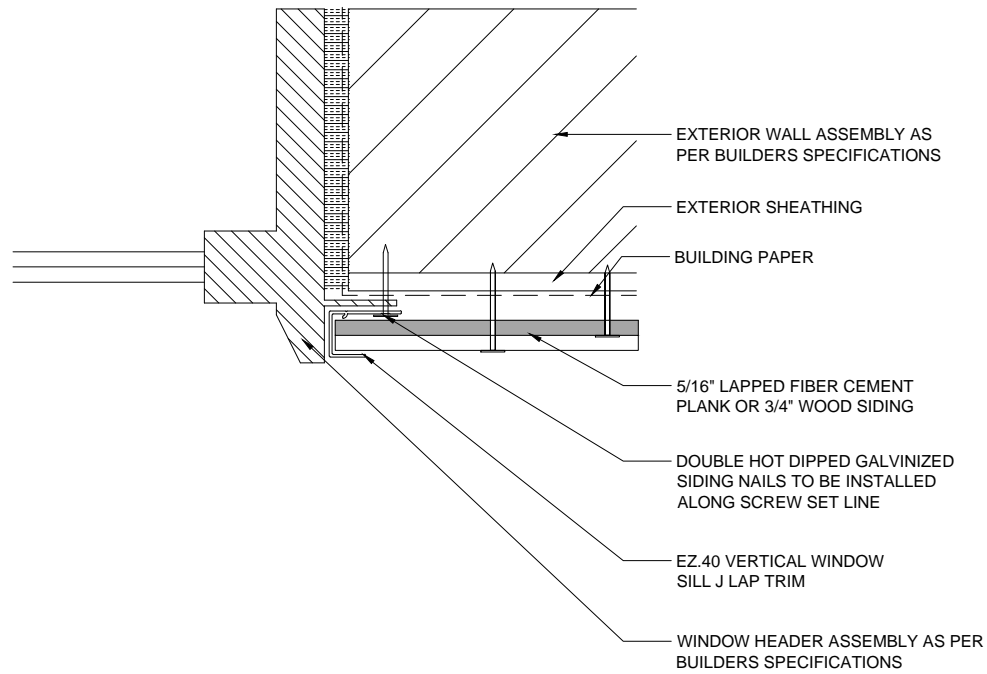

31 TYPICAL EZ.40 VERTICAL WINDOW SILL J LAP TRIM
 A10 SCALE: 3" = 1'-0"

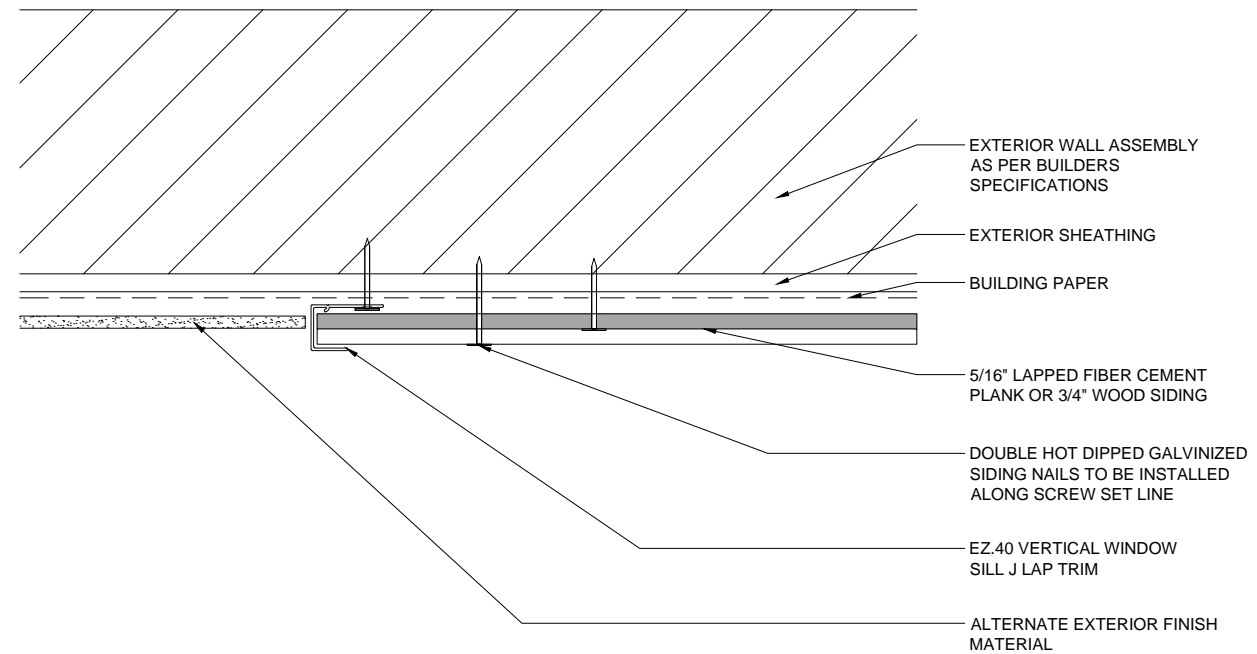

32 ALTERNATE EZ.40 VERTICAL WINDOW SILL J LAP TRIM
 A10 SCALE: 3" = 1'-0"

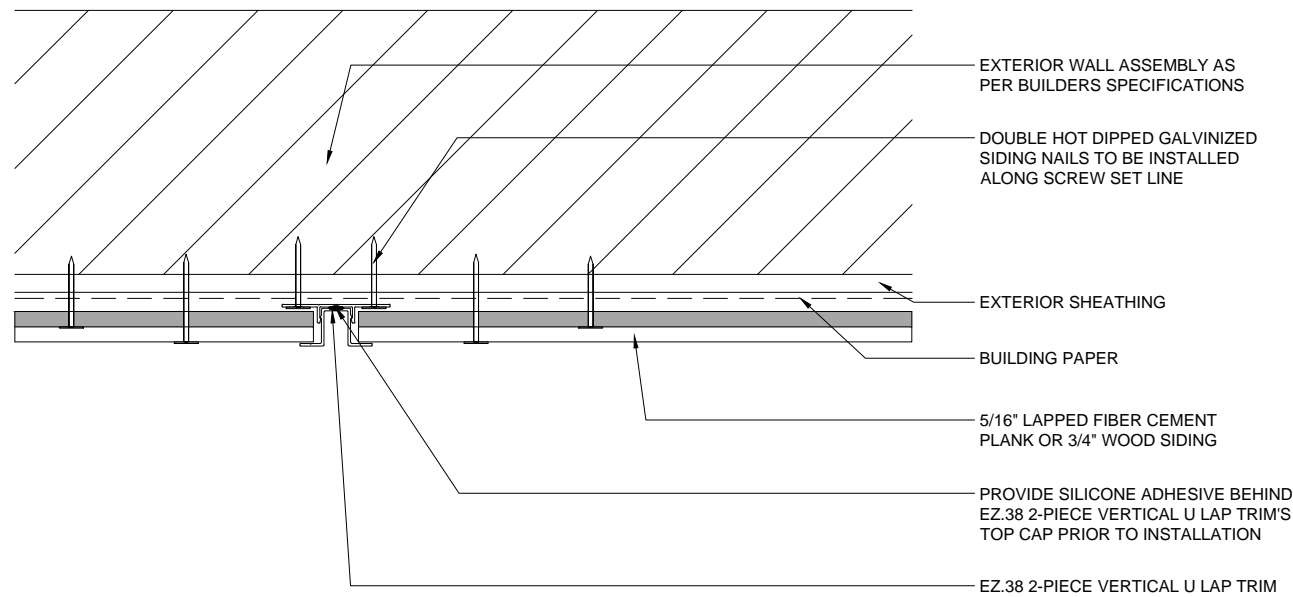

33 TYPICAL EZ.38 2-PIECE VERTICAL U LAP TRIM
 A10 SCALE: 3" = 1'-0"

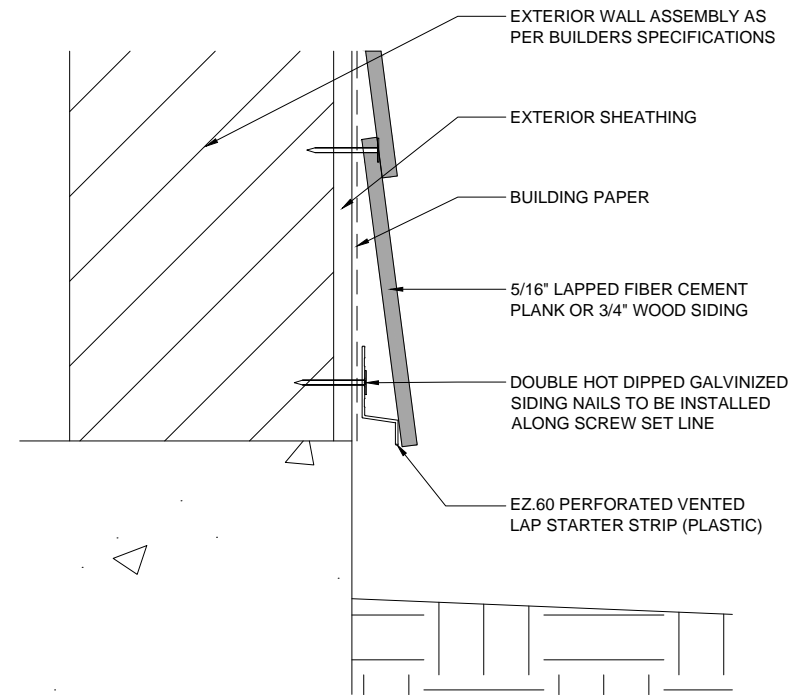

34 TYPICAL EZ.60 PERFORATED VENTED LAP STARTER STRIP (PLASTIC)
 A10 SCALE: 3" = 1'-0"

The contractor / builder must verify all dimensions on the job and report any discrepancy to the designer before proceeding with the work. Drawings are NOT to be scaled. All drawings and specifications are instruments of service and the copyright property of the designer and must be returned upon request.

DRAWN / REVISED BY:	REVIEWED BY:
DATE ISSUED:	DRAWING NUMBER:
PROJECT NUMBER:	A10
SCALE:	

Fiber Cement Trim System

by EasyTrim Reveals

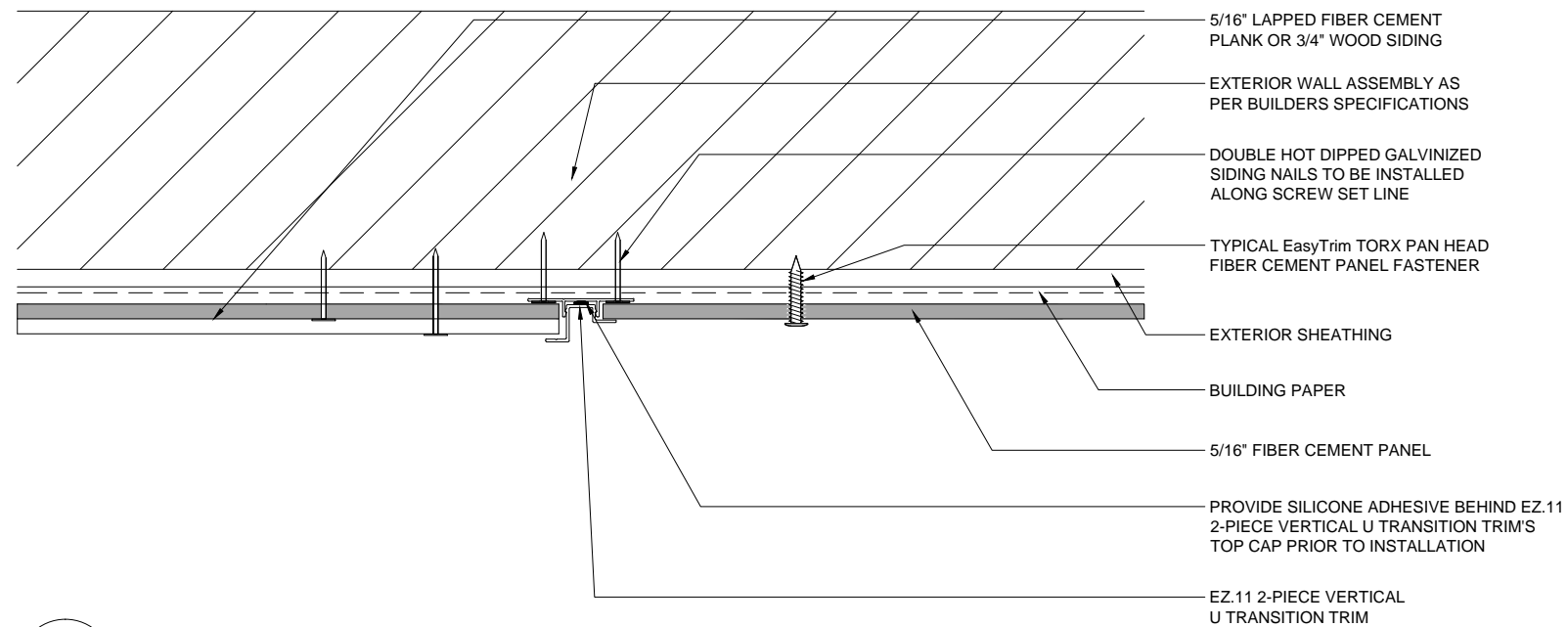

35 TYPICAL EZ.11 2-PIECE VERTICAL U TRANSITION TRIM
 A11 SCALE: 3" = 1'-0"

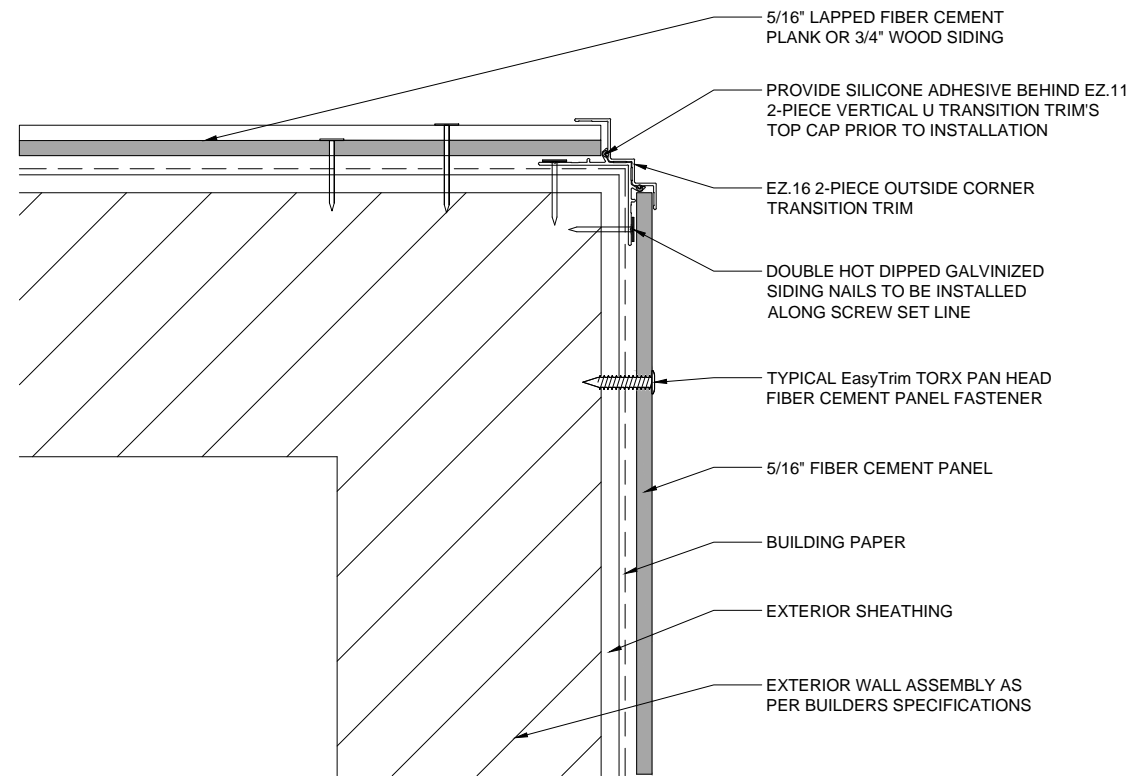

36 TYPICAL EZ.16 2-PIECE OUTSIDE CORNER TRANSITION TRIM
 A11 SCALE: 3" = 1'-0"

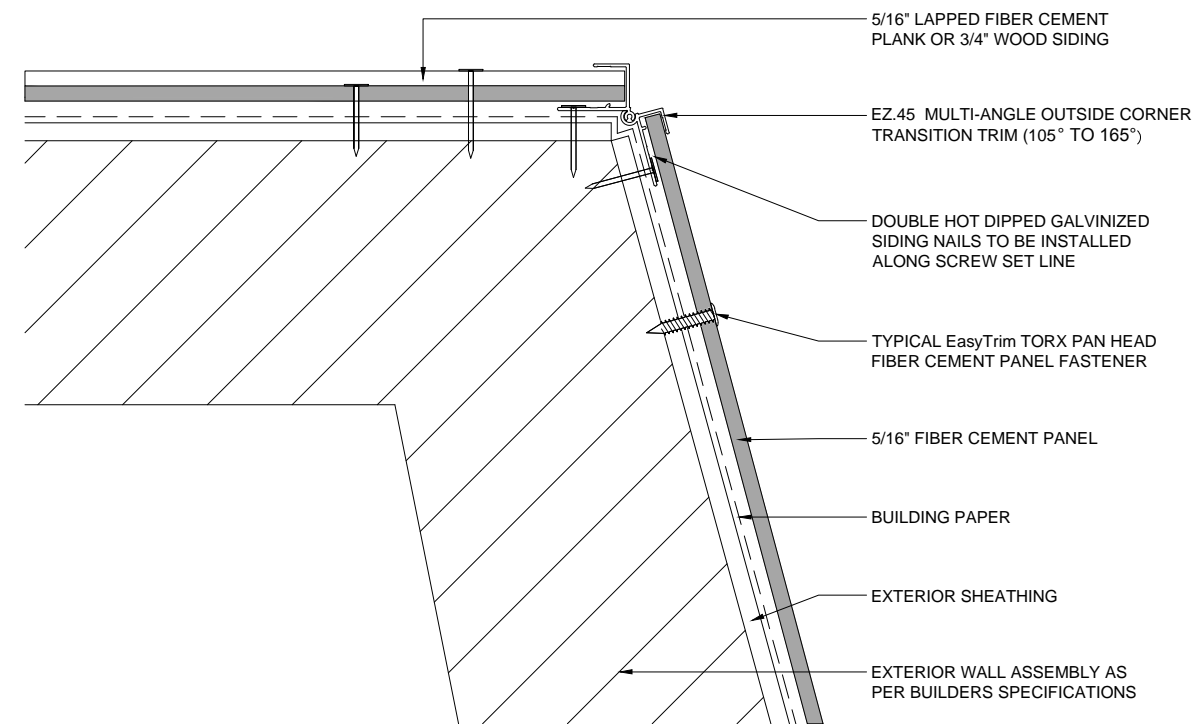

37 TYPICAL EZ.45 MULTI-ANGLE OUTSIDE CORNER TRANSITION TRIM (105° TO 165°)
 A11 SCALE: 3" = 1'-0"

The contractor / builder must verify all dimensions on the job and report any discrepancy to the designer before proceeding with the work. Drawings are NOT to be scaled. All drawings and specifications are instruments of service and the copyright property of the designer and must be returned upon request.

DRAWN / REVISED BY:	REVIEWED BY:
DATE ISSUED:	DRAWING NUMBER:
PROJECT NUMBER:	A11
SCALE:	

Fiber Cement Trim System

by EasyTrim Reveals

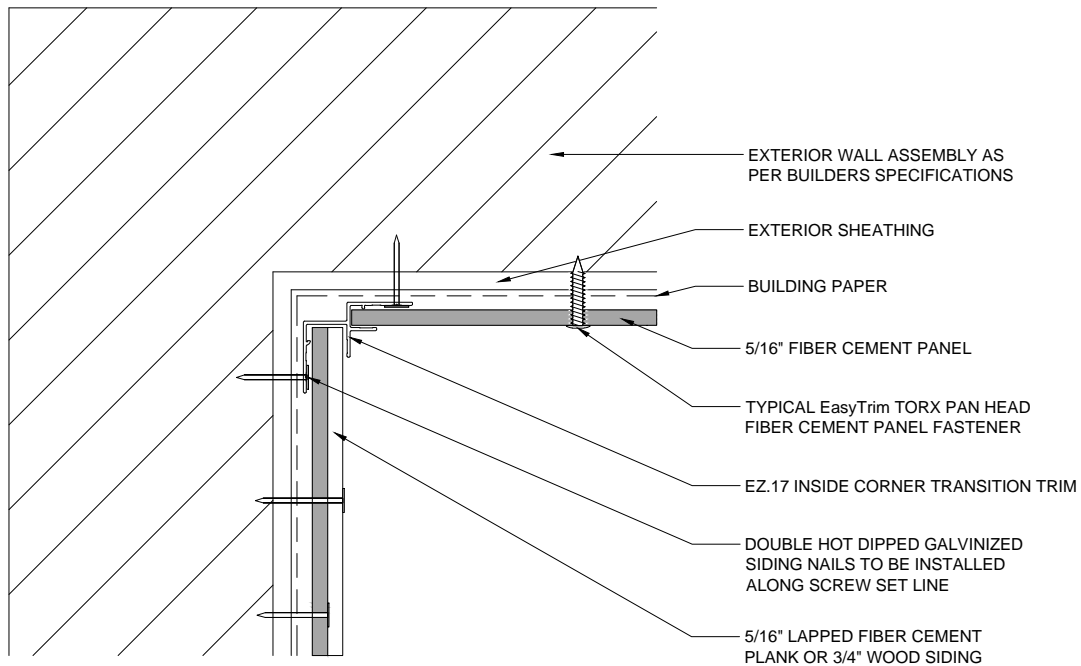

38 TYPICAL EZ.17 INSIDE CORNER TRANSITION TRIM
 A12 SCALE: 3" = 1'-0"

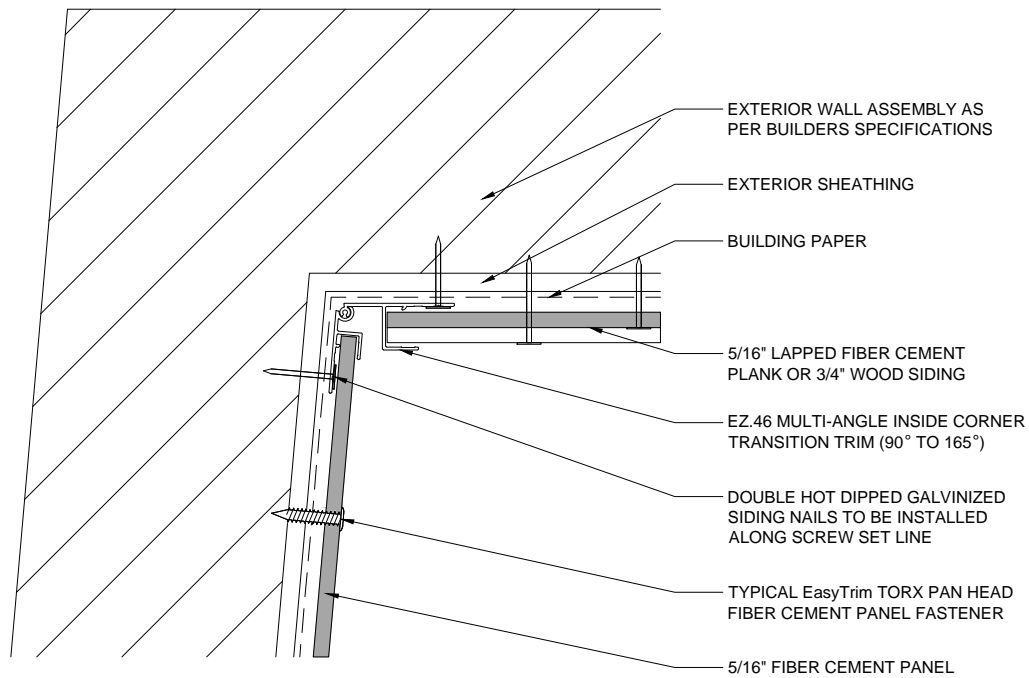

39 TYPICAL EZ.46 MULTI-ANGLE INSIDE CORNER TRANSITION TRIM (90° TO 165°)
 A12 SCALE: 3" = 1'-0"

The contractor / builder must verify all dimensions on the job and report any discrepancy to the designer before proceeding with the work. Drawings are NOT to be scaled. All drawings and specifications are instruments of service and the copyright property of the designer and must be returned upon request.

DRAWN / REVISED BY:	REVIEWED BY:
DATE ISSUED:	DRAWING NUMBER:
PROJECT NUMBER:	A12
SCALE:	